

符合RoHS指令要求  
CONFORM TO RoHS INSTRUCTIONS

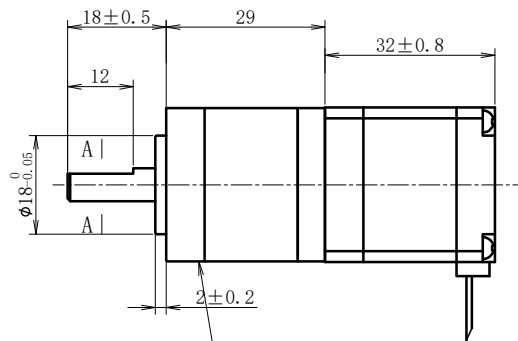

减速箱5.18:1

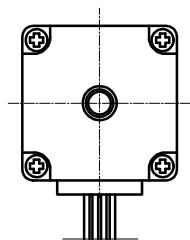
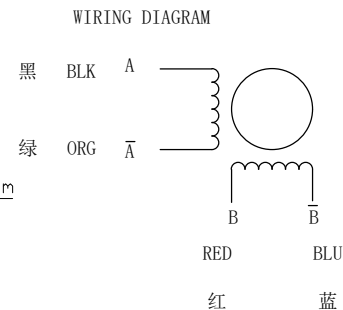
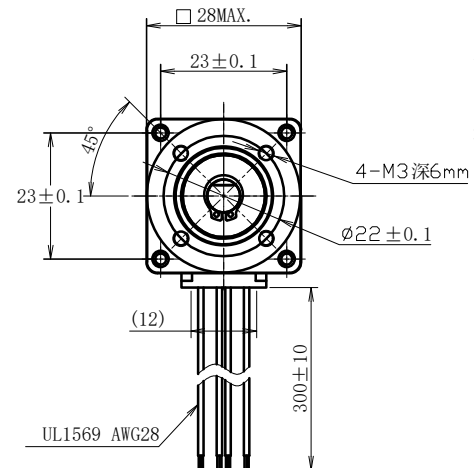

电器特性参数/ELECTRICAL PARAMETER

步进角 STEP ANGLE	1.8° ±5%
相数 NO. OF PHASES	2
额定电压 RATED VOLTAGE	3.752 V
额定电流 RATED CURRENT	0.67 A
电阻 RESISTANCE	5.6 ohm±10% AT 25° C
电感 INDUCTANCE	4.2 mH±20%
保持力矩 HOLDING TORQUE	60mN.m
运行力矩 (---PPS) RUNING TORQUR(AT --PPS)	--- MAX. (24VDC, RATED CURRENT, FULL STEP)
绝缘耐压 DIELECTRIC STRENGTH	500V AC 1 MINUTIE
绝缘电阻 INSULATION RESISTANCE	100 MΩ MIN.
绝缘等级 INSULATION CLASS	B
温度上升 TEMPERATURE RISE	80K MAX. (SEE NOTE 2)
转子惯量 ROTOR INERTIA	480g.cm <sup>2</sup> (2.63 oz-in <sup>2</sup> )
重量 WEIGHT	APPROX. 1100g (38.8 OZ)
允许轴向负载 ALLOWABLE THRUST LOAD	15N
允许径向负载 ALLOWABLE RADIAL LOAD	75N(ON THE SHAFT END)
环境温度 AMBIENT TEMPERATURE	0° C TO +50° C
环境湿度 AMBIENT HUMITITY	15% TO 95%
寿命 LIFE	3000 HOURS (SEE NOTE)

A-A(2:1)

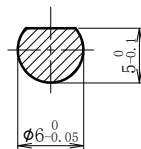

CONFIRMED&ACCEPTED BY COTUMER (客户确认&接受)				物料编码			
CUSTOMER'S COMPANY CHOP&SIGNATURE 盖章&签名							
一般公差 TOLERANCE	±0.3/±3°	版本 REV.	年月日 DATE	变更番号 ECO NO.	变更内容 REVISIONS	设计 BY	备注 NOTE
制图/DRAWN		比例 SCALE	1:1	品名 TITLE	28H232-0674AG5.18		三视图 THIRD ANGLE PROJECTION
设计/DESIGNED		单位 UNIT	mm				
审核/CHECKED		上海四横电机制造有限公司				页 SHEET	1/1
承认/APPROVED							